

Electric Control Valves Types 3226/5857, 3226/5824, 3226/5825, 3226/5757-7, 3226/5725-7



Pneumatic Control Valve Type 3226/2780

Three-way Valve Type 3226

Application

Control valves available as mixing or diverting valves for heating, ventilation and air-conditioning systems.

DN 15 to DN 50, G ½ to G 1 · PN 25 · Version up to 150 °C (water and non-flammable gases)



Special features

- Type 3226 Three-way Valve designed as a **mixing valve** with male thread connection and welding ends or threaded ends (DN 15 to 50) or with female thread connection (G ½ to G 1)
- Type 3226 Three-way Valve designed as a **diverting valve** with male thread connection and welding ends or threaded ends (DN 15 to 50)
- Type 3226 Three-way Valve combined with Types 5857 and 5757-7 (with special spring)
- Force-locking connection between valve and actuator
- Type 3226 Three-way Valve in special version: DVGW-tested

Versions

Electric control valves		
Type 3226/5857	PN 25	DN 15 to 25 G ½ to 1
Type 3226/5824	PN 25	DN 15 to 50 G ½ to 1
Type 3226/5825 ¹⁾	PN 25	DN 15 to 50 G ½ to 1
Electric control valves/controller with electric actuator for heating and cooling applications		
Type 3226/5757-7	PN 25	DN 15 to 25 G ½ to 1
Type 3226/5725-7 ¹⁾	PN 25	DN 15 to 50 G ½ to 1
Pneumatic control valves		
Type 3226/2780-1	PN 25	DN 15 to 50 G ½ to 1
Type 3226/2780-2 ²⁾	PN 25	DN 15 to 50 G ½ to 1

¹⁾ Electric actuators with fail-safe action

²⁾ Pneumatic actuator suitable for integral positioner attachment

Also available:

Type 3226 Three-way Valve with flanges (refer to Data Sheet T 5861 EN)



Fig. 1 · Type 3226/5824 (version with female thread)



Fig. 2 · Type 3226/2780-1 (version with welding ends)

Principle of operation (Fig. 3)

The three-way valve in the version with male thread connection and welding ends or threaded ends can be used for both mixing or flow-diverting valves. The valves vary in the plug arrangement and must be installed accordingly. The version with female thread connection can only be used for mixing valves.

The process medium flows through the three-way valve in the direction indicated by the arrow. The position of the plug (3) determines the cross-sectional area of flow between the plug and the seat (2). The plug stem follows the actuator stem, which is changed by the control signal acting on the actuator, owing to the force of the valve spring (5).

The valve (1) and actuator (8) have a force-locking connection.

Fail-safe position

For three-way valves mounted to an actuator with fail-safe action, the control valve has two different positions which become effective upon power supply failure:

Actuator stem extends

- Port B of the mixing valve closes upon power supply failure
- Port A of the diverting valve closes upon power supply failure

Actuator stem retracts

- Port A of the mixing valve closes upon power supply failure
- Port B of the diverting valve closes upon power supply failure

Electric actuators

The Types 5857, 5824 und 5825 Electric Actuators can either be controlled using a three-stepping point signal or, in the version with positioner, with continuous signals which can be adjusted in ranges from 0 to 20 mA or 0 to 10 V. Various optional electric accessories can be mounted onto the control valve.

The Type 5825 Electric Actuator is able to perform a fail-safe action. Refer to Table 4.

Refer to the data sheets for more details on the electric actuators:

- **T 5857 EN:** Type 5857 Electric Actuator
- **T 5824 EN:** Types 5824 and 5825 Electric Actuators

Controllers with electric actuators

The actuator consists of a digital controller which is integrated into the electric actuator housing. The Types 5757-7 and 5725-7 Controllers with Electric Actuators are suited for heating and cooling applications. They are controlled by continuous signals which can be adjusted in ranges from 0 to 20 mA or 0 to 10 V.

Type 5725-7 is able to perform a fail-safe action. Refer to Table 4.

Refer to the data sheets for more details on the controllers with electric actuators:

- **T 5757-7 EN:** Type 5757-7 Controller with Electric Actuator for heating and cooling applications
- **T 5725-7 EN:** Type 5725-7 Controller with Electric Actuator for heating and cooling applications

Pneumatic actuators

A control signal from 0.4 to 1 bar is used by the Type 2780-1 Pneumatic Actuator and a control signal from 0.4 to 2 bar is used by Type 2780-2 Pneumatic Actuator at the loading pressure connection. The pneumatic actuators require a supply pressure of at least 0.2 bar above the maximum bench range. The actuators are available for fail-safe action "Actuator stem extends (FA)" or "Actuator stem retracts (FE)".

The Type 2780-2 Actuator is suitable for integral positioner attachment.

Refer to the data sheet for more details on the pneumatic actuators:

- **T 5840 EN:** Types 2780-1 and 2780-2 Pneumatic Actuators

Installation of the control valve

The control valves can be mounted in any position. However, the electric actuators and the controllers with electric actuators must not be suspended downwards.

Make sure that the maximum ambient temperature of 50 °C for the actuator, which is attached to the valve bonnet, is not exceeded. Make sure that the inlet and outlet flows of the plant are correctly assigned to ports A, B, and AB. Fig. 4 schematically illustrates a few typical applications.

Strainers must be installed upstream of the inlets of valves mounted on actuators with fail-safe action (e.g. Type 1N or Type 1FN).

Ordering text

Control Valve Type:

- 3226/5857, 3226/5824-..., 3226/5825-...,
- 3226/5757-7, 3226/5725-7-...,
- 3260/2780-1, 3226/2780-2

- Valve type: mixing valve, diverting valve
- End connections:
 - male thread connection and welding ends DN...
 - male thread connection and threaded ends DN...
 - female thread connection G ...
- Kvs coefficient: ...
- DVWG version: yes, no

Further specifications for electric actuator

- Control signal: three-stepping point signal, continuous (positioner)
- Power supply: ...
- Additional electric equipment: ...

Further specifications for pneumatic actuator

- Loading pressure connection for Type 2780-1: G $\frac{1}{8}$, $\frac{1}{8}$ NPT
- Fail-safe position: stem extends (FA), stem retracts (FE)

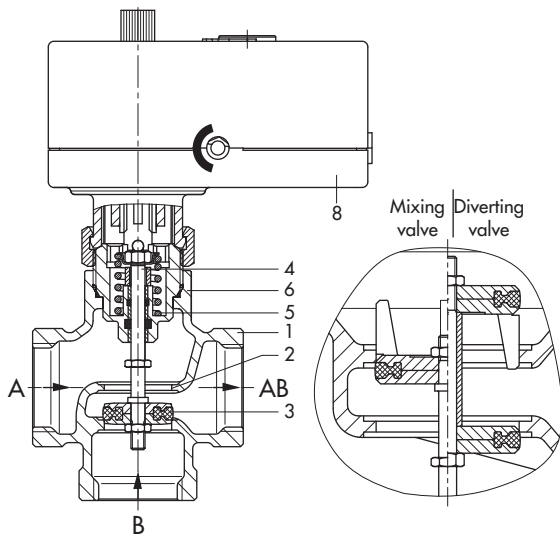

- 1 Valve body
- 2 Seat
- 3 Plug
- 4 Plug stem
- 5 Valve spring
- 6 Adapter
- 8 Actuator

Fig. 3 · Left: Functional diagram of Type 3226/5857 as mixing valve
 Right: Plug arrangement for version with male thread connection
 (mixing and diverting valve)

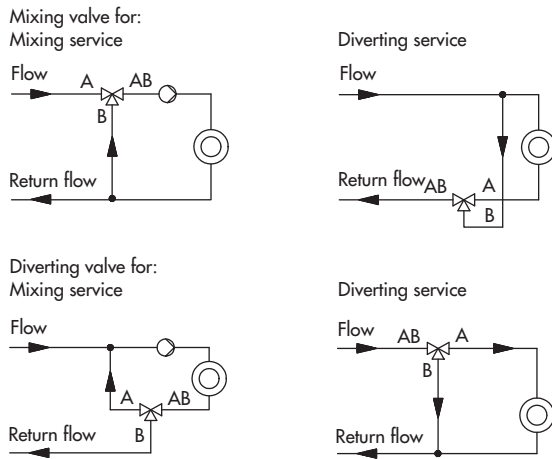

Fig. 4 · Typical installations

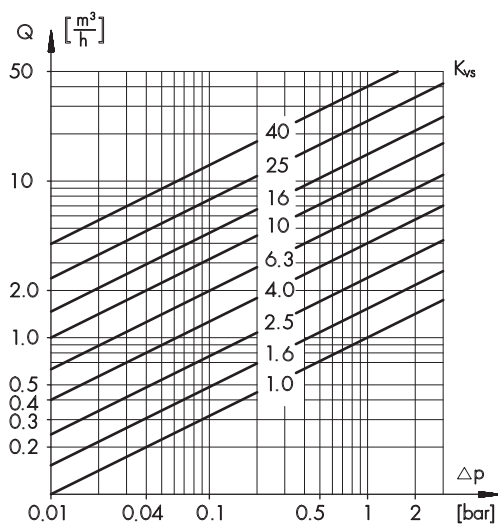

Fig. 5 · Flow rate diagram for water

Table 1 · Technical data · All pressures in bar (gauge)

Type 3226 Three-way Valve								
Nominal size	Mixing or diverting valve with welding ends or threaded ends	DN	15	20	25	32	40	50
Thread size	Mixing valve with female thread	G	½	¾	1	–	–	–
Nominal pressure		PN	25					
DVGW version		PN	10					
Permissible temperature range		°C	+5 (–15 ¹⁾) to 150 ²⁾					
DVGW version		°C	+5 to 90 °C ³⁾					
Permissible differential pressure for actuators								
Types 5857, 5757-7		bar	4	2.6	1.8	–	–	–
Types 5824, 5825, 5725-7, 2780		bar	4	4	4	1.7	1.1	1.1
Rated travel		mm	6	6	6	12	12	12
Seat/plug sealing	Soft sealing							
Leakage rate acc. to DIN EN 60534-4	Class IV (≤0.05 % of the K _{V5} coefficient)							

1) Version for water: –15 to +5 °C with intermediate insulating section (1990-1712).

2) Use an intermediate insulating section (1990-1712) for networks with constant media temperatures between 130 to 150 °C.

3) **Special version DVGW-tested:** Only as diverting valve

Special version DVGW-compliant (materials and lubricants same as DVGW-tested): Only as mixing valve

Table 2 · Materials

Type 3226 Three-way Valve	
Valve body	CC491K (G-CuSn5ZnPb)
Plug	CW617N (CuZn40Pb2zh) with EPDM
Packing	O-rings made of FKM and EPDM
Welding ends	St 37
Threaded ends	Red brass

Table 3 · Overview: Nominal sizes and K_{V5} coefficients: Type 3226 Three-way Valve

Type 3226 Three-way Valve											
Nominal size	Mixing or diverting valve with male thread connection	DN	15			20	25	32	40	50	
Thread size	Mixing valve with female thread connection	G	½			¾	1	–	–	–	
K _{V5} coefficient			1.0	1.6	2.5	4	6.3	10	16	25	40
Rated travel		mm	6	6	6	6	6	6	12	12	12

Table 4 · Possible combinations

Type 3226 Three-way Valve/actuator													
Type	Fail-safe action: Actuator stem		Refer to Data Sheet	Nominal size DN						Connection size G			
	extends	retracts		15	20	25	32	40	50	½	¾	1	
Electric actuators													
5857 ¹⁾	–	–	T 5857 EN	•	•	•	–	–	–	–	•	•	•
5824-10	–	–	T 5824 EN	•	•	•	–	–	–	–	•	•	•
5824-13 ²⁾	–	–		•	•	•	–	–	–	–	•	•	•
5825-10	•	–		•	•	•	–	–	–	–	•	•	•
5825-13 ²⁾	•	–		•	•	•	–	–	–	–	•	•	•
5825-15	–	•		•	•	•	–	–	–	–	•	•	•
5824-20	–	–		–	–	–	•	•	•	–	–	–	–
5824-23 ²⁾	–	–		–	–	–	•	•	•	–	–	–	–
5825-20	•	–		–	–	–	•	•	•	–	–	–	–
5825-23 ²⁾	•	–		–	–	–	•	•	•	–	–	–	–
5825-25	–	•		–	–	–	•	•	•	–	–	–	–
Controller with electric actuator for heating and cooling applications													
5757-7 ¹⁾	–	–	T 5757-7 EN	•	•	•	–	–	–	–	•	•	•
5725-710	•	–	T 5725-7 EN	•	•	•	–	–	–	–	•	•	•
5725-715	–	•		•	•	•	–	–	–	–	•	•	•
5725-720	•	–		–	–	–	•	•	•	–	–	–	–
5725-725	–	•		–	–	–	•	•	•	–	–	–	–
Pneumatic actuators													
2780-1	•	•	T 5840 EN	•	•	•	•	•	•	•	•	•	•
2780-2	•	•		•	•	•	•	•	•	•	•	•	•

¹⁾ The valve spring in the Type 3226 Valve intended for mounting on the Type 5857 Actuator is different from that of the Type 3226 intended for mounting on Types 5824/5825 Electric Actuators and Types 2780-1/-2 Pneumatic Actuators. Actuators with a larger nominal thrust (e.g. Type 5824) may also be combined with valves for Type 5857 Actuator, however, not vice versa.

²⁾ Actuator with half transit time

Table 5 · Dimensions and weights

Table 5.1 · Type 3226 Three-way Valve							
Valve with male thread connection							
Nominal size	DN	15	20	25	32	40	50
Length L	mm	65	70	75	100	110	130
Height H2	mm	51			61		
Height H3	mm	40	40	40	60	65	65
... with welding ends							
Connection size R	G	¾	1	1¼	1¾	2	2½
Pipe Ød	mm	21.3	26.8	33.7	42	48	60
Width across flats SW		30	36	46	59	65	82
Length L2	mm	210	234	244	268	294	330
Height H4	mm	112	122	124	149	162	175
Weight without actuator	kg	3.2	3.6	4.0	6.1	7.0	8.0
... with threaded ends							
Male thread A	G	½	¾	1	1¼	1½	2
Width across flats SW		30	36	46	59	65	82
Length L3	mm	128	143	158	179	195	227
Height H5	mm	71.5	76.5	81.5	99	108	114
Weight without actuator	kg	3.2	3.6	4.0	6.1	7.0	8.0
Valves with female thread							
Connection size	G	½	¾	1	–		
Length L1	mm	65	75	90	–		
Height H1	mm	40	40	40	–		
Height H2	mm	51			–		
SW1		27	34	46	–		
Weight without actuator	kg	0.9	1.1	1.3	–		

Table 5.2 · Electric actuators			
Type	5857	5824	5825
Weight approx. kg	0.7	1.0	1.25

Table 5.3 · Controller with electric actuator		
Type	5757-7	5725-7
Weight approx. kg	0.7	1.3

Table 5.4 · Pneumatic actuators		
Type	2780-1	2780-2
Weight approx. kg	2	3.2

Specifications subject to change without notice.

Type 3226 Three-way Valve with male thread connection and welding ends

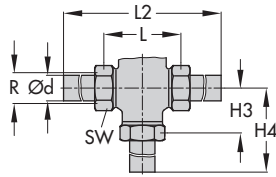

Type 3226 Three-way Valve with male thread connection and threaded ends

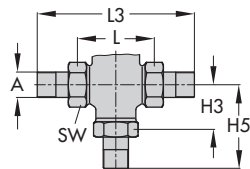

Type 3226 Three-way Valve with female thread

Electric control valves

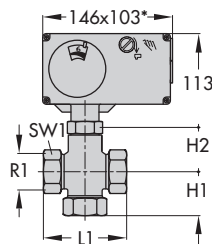
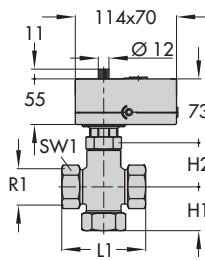

Type 3226/5857: DN 15 to 25
Type 3226/5757-7: DN 15 to 25

Type 3226/5824: DN 15 to 50
Type 3226/5825: DN 15 to 50
Type 3226/5725-7: DN 15 to 50

* Dimensions for Type 5824-x3
and Type 5825-x3 Actuators:
146 x 136

Pneumatic control valves

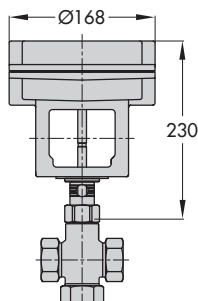
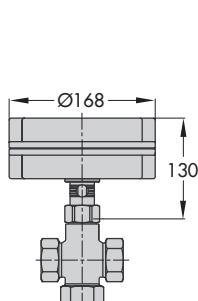

Type 3226/2780-1: DN 15 to 50

Type 3226/2780-2: DN 15 to 50



SAMSON AG · MESS- UND REGELTECHNIK
Weismüllerstraße 3 · 60314 Frankfurt am Main · Germany
Phone: +49 69 4009-0 · Fax: +49 69 4009-1507
Internet: <http://www.samson.de>

T 5863 EN

2010-11