

Application

Control of maximum two control circuits.



The TROVIS 5573 Heating and District Heating Controller is used to control max. two control circuits:

- Control of a primary heat exchanger or boiler
Max. one mixing and one non-mixing heating circuit (both weather-compensated) as well as control of DHW heating in the secondary circuit
- Control of a weather-compensated heating circuit and a DHW heating with two valves in the primary circuit
- Control of two weather-compensated heating circuits with two valves in the primary circuit

Special features

- Direct access to the operating modes and essential parameters of each control circuit using rotary switch
- Intuitive data retrieval and input by pressing and turning the rotary pushbutton
- 365-day clock with max. four time schedules and automatic summer time/winter time changeover; maximum three times-of-use per day (input in steps of 15 minutes)
- Room panels to override operating mode and day set point can be connected for each heating circuit
- Demand-driven control by a set point request of subsequent control circuits over a 0 to 10 V signal:
The primary circuit controls the maximum required flow temperature plus adjustable boost
- Application with solar thermal DHW heating available
- Heating characteristics either according to gradient or four points; variable limitation of the return flow temperature
- Adaptation: automatic adaptation of the heating characteristic (room temperature sensor required)
- Optimization: calculation of the best possible activation and deactivation times of the heating (room temperature sensor required)
- Drying of jointless floors function with adjustable parameters
- Flash EPROM of controller (operating system) can be updated
- Configuration and parameterization using a memory module
- Data logging function:
 - Operating data can be saved to a data logging module
 - Data can be displayed in the data log viewer on the PC



Fig. 1 · TROVIS 5573 Heating and District Heating Controller

Inputs and outputs

- Eight inputs for Pt 1000 temperature sensors and two binary inputs
- One input for 0 to 10 V signal, can alternatively be used as an output for 0 to 10 V signal
- Three-step or on/off control circuit outputs configurable with PI control algorithm

Operation

The TROVIS 5573 Heating and District Heating Controller is adapted to the specific plant by setting the appropriate system code number. To select the appropriate code number, refer to the plant schematics described in the associated mounting and operating instructions. Additional sensors and/or function blocks which are not part of the plant's basic configuration may be selected using function blocks.

Place the the rotary switch to  and enter the key number to get to the different levels. For access by trained staff, the configuration levels used to set function blocks are indicated by "CO" and the parameter levels are indicated by "PA". There is, for example, a clear distinction between two heating circuit levels and the DHW level.

Data are retrieved and entered at the controller using a rotary pushbutton. This process is facilitated by icons displayed on the LCD. The rotary switch is used to set the operating mode and the parameters required for each circuit (Fig. 2).

Electrical connection and installation

The controller consists of the controller housing containing the electronics and a separate terminal board for electrical connection. Two wires of max. 1.5 mm² can be connected to each terminal. The sensor connecting lines must be installed separately from the lines carrying the operating voltage. For wall mounting, screw the terminal board to the wall. After the electrical connections have been installed, place the controller housing onto the terminal board and fasten it with two screws. Two adjustable fixing clamps attached to the controller are used for panel mounting.

Ordering text

Heating and District Heating Controller **TROVIS 5573-000x** with standard back panel/high back panel



Options

- Communications module RS-232/PC 8812-2009
- Communications module RS-232/modem 8812-2004
- Communications module RS-485 8812-2002
- Meter bus plug-in module 1400-9867
- Visualization and operator interface 55Viewer 1400-9770

Accessories

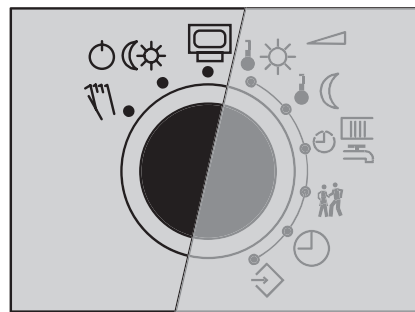
- Type 5257-5 Room Panel
- Memory module 1400-9379
- Mini module 1400-7436
- Data logging module 1400-9378
- USB converter 3 together with data log viewer software 1400-9377
- TROVIS-VIEW Configuration and Operator Interface 6661-1014 for TROVIS 5573



-  Information level
-  Operating modes
-  Manual level

Parameters

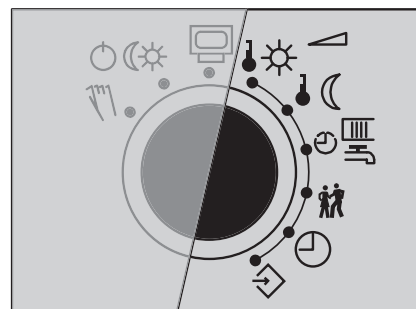







-  Day set point
-  Night set point
-  Times-of-use for heating/DHW
-  Party mode: setting of special times-of-use in steps of 15 minutes. Timer starts working immediately after it is set.
-  Controller clock: Setting of time, date and year
-  Access to parameter and configuration levels

Fig. 2 · Switch positions and their meaning

Technical data

Inputs	8 inputs for Pt 1000 temperature sensors and two binary inputs, Input terminal 11 for 0 to 10 V signal for heat demand required by subsequent control circuits (0 to 10 V correspond to 20 to 120 °C flow temperature)
Outputs*	2 x three-step signal: load max. 250 V AC, 2A Alternatively 2 x on/off signal: load max. 250 V AC, 2 A 3 x pump outputs: load max. 250 V AC, 2A All outputs are relay outputs with varistor suppression Input terminal 11 alternatively can be used as 0 to 10 V output for continuous-action control Rk1 or signal for heat demand, load > 5 kΩ)
Optional interfaces	– Modbus RS-23 interface for modem using RS-232 communication module/modem – Modbus RS-485 interface for two-wire bus using RS-485 communication module (Modbus RTU protocol, data format 8N1, RJ-45 jack located at the side)
Operating voltage	85 to 250 V, 48 to 62 Hz, max. 1.5 VA
Ambient temperature	0 to 40 °C (operation), -10 °C to 60 °C (storage and transport)
Degree of protection	IP 40 according to IEC 529
Class of protection	II according to VDE 0106
Degree of contamination	2 according to VDE 0110
Overvoltage category	II according to VDE 0110
Humidity rating	F according to VDE 40040
Noise immunity	According to EN 61000-6-1
Noise emission	According to EN 61000-6-3
Weight	Approx. 0.5 kg

* For systems with one control circuit, max. 4 pump outputs are available.

Dimensions in mm

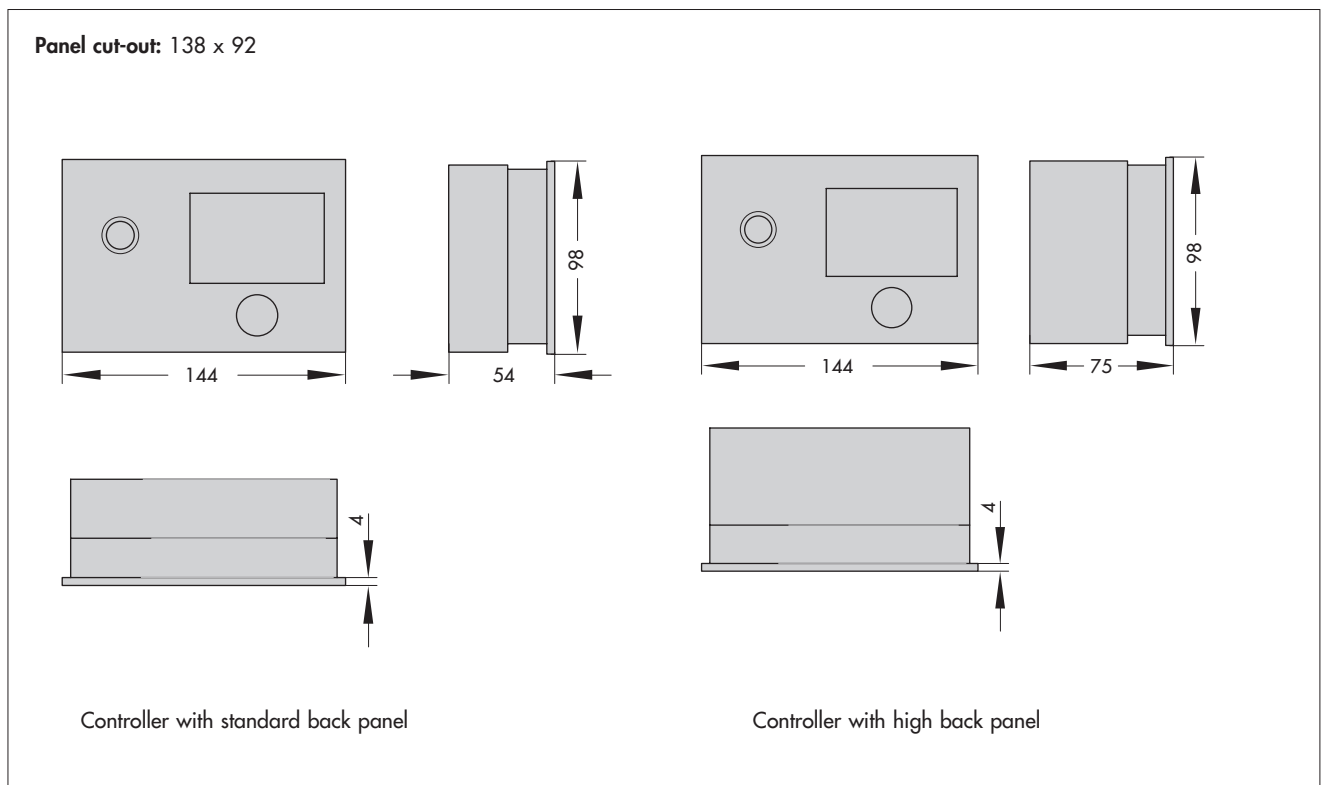

Terminal assignment

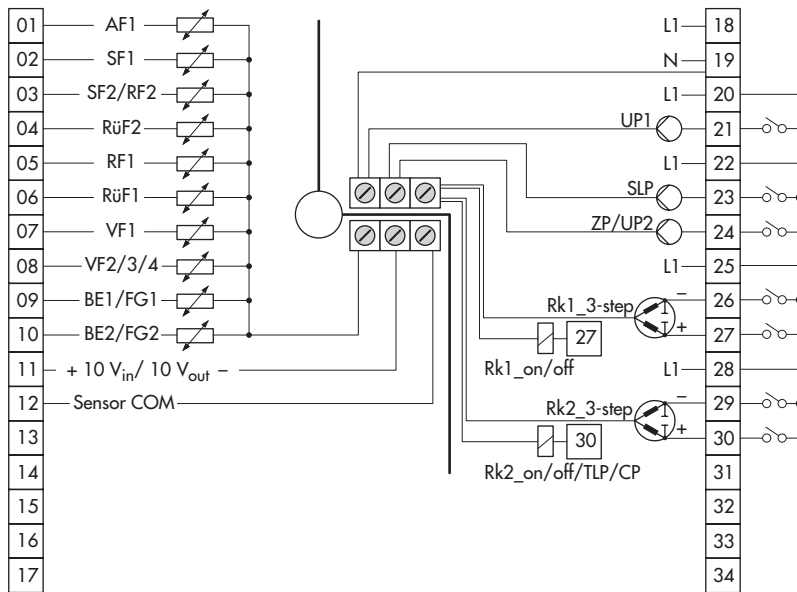

Fig. 3 · Terminal assignment of TROVIS 5573 Controller with standard back panel

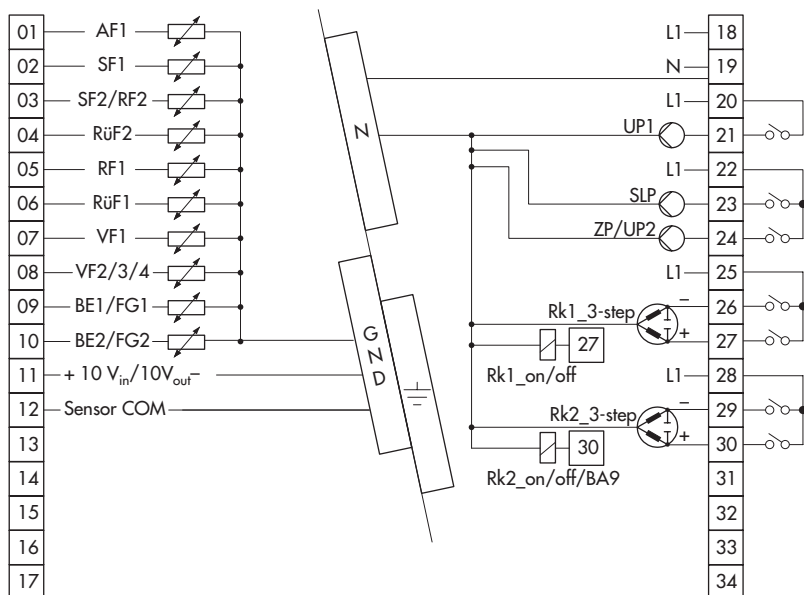

Fig. 4 · Terminal assignment of TROVIS 5573 Controller with high back panel

AF	Outdoor temperature sensor	CP	Solar circuit pump
BE	Binary input	UP	Circulation pump (heating)
FG	Potentiometer	SLP	Storage tank charging pump
RF	Room temperature sensor	TLP	Heat exchanger charging pump
Rüf	Return flow temperature sensor	ZP	Circulation pump (DHW)
SF	Storage tank sensor		
VF	Flow sensor	Rk	Control circuit

Specifications subject to change without notice.