

Automation System TROVIS 5500

TROVIS 5576 Heating and District Heating Controller



Application

Control of max. two control circuits. To control more circuits, several controllers can be linked by a device bus. The controller can communicate with up to six heat meters using the retrofittable meter bus plug-in module.



The TROVIS 5576 Heating and District Heating Controller is used to control max. two control circuits:

Control of a primary heat exchanger or boiler with max. one mixing and one non-mixing heating circuit (both weather-compensated) as well as control of DHW heating in the secondary circuit

- Control of one weather-compensated heating circuit and a DHW heating with two valves in the primary circuit
- Control of two weather-compensated heating circuits with two valves in the primary circuit

Special features

- Rotary switches for direct access to the operating modes and essential parameters of the control circuits
- Intuitive data retrieval and input by pressing and turning the pushbutton
- Illuminated display
- 365-day clock with max. four time schedules and automatic summer time/winter time changeover; maximum three times-of-use per day (input in steps of 15 minutes)
- Room panels may be connected for each heating circuit:
 - Convenient room panels for adjustment of the operating mode, the day and night set points, the times-of-use for heating, the controller clock and party mode. Additional outdoor and room temperature readings. Connection via device bus
 - Room panel to override operating mode and rated room temperature
- Demand-driven control by set point demand by subsequent controllers over a device bus or 0 to 10 V signal. The primary circuit controls the maximum flow temperature demanded plus adjustable boost.
- Applications with solar hot water system available
- Instantaneous heating systems with water flow sensor configurable
- Heating characteristics optionally based on the gradient or based on four points; variable return flow temperature limitation



Fig. 1: TROVIS 5576 Heating and District Heating Controller

- Adaptation: automatic adaptation of the heating characteristic (room temperature sensor required)
- Optimization: calculation of the best possible activation and deactivation times for the heating (room temperature sensor required)
- Drying of jointless floors function with adjustable parameter settings
- Pump management function: speed changeover for a heating circulation pump available
- Data logging function:
 - Operating data can be saved internally and/or saved to a data logging module
 - Data can be displayed in the data log viewer on a PC

Inputs and outputs

- 15 configurable inputs for Pt 1000/Pt 100, PTC/Pt 100, NTC/Pt 100, Ni 1000/Pt 100 or Pt 500/Pt 100 temperature sensors and binary inputs
- Three-step, on/off or continuous-action control circuit outputs (0 to 10 V) configurable with PID control algorithm

Communication

- RS-232 interface for modem or point-to-point connection to a PC
- Configuration and parameterization either using memory module or online using USB converter 3 and TROVIS-VIEW software
- Alarm notification by text message (modem required)
- Flash EPROM of the controller (operating system) can be updated via the RS-232 system bus interface (also via modem) and the RS-485 interface (via cable converter)
- RS-232/RS-485 cable converter for communication with the bus (optional)
- Meter bus plug-in module for communication with up to six heat meters (optional)

Operation

The TROVIS 5576 Heating and District Heating Controller is adapted to the specific system by setting the appropriate system code number. To select the code number, refer to the system schematics described in the associated mounting and operating instructions. Additional sensors and/or functions which are not part of the system's basic configuration may be selected over function blocks.

Press the changeover key  to access the different levels. For trained staff, the configuration levels used to set function blocks are indicated by "CO" and the parameter levels are indicated by "PA". For example, a clear distinction is made between two heating circuit levels, a domestic hot water level and a communication level.

Data is retrieved and entered at the controller using a rotary pushbutton. This process is facilitated by icons displayed on the LCD. The three rotary switches are used to set the operating mode (left) and the parameters required for each circuit (right) as illustrated in Fig. 2.





Meter bus plug-in module

The meter bus plug-in module allows simple connection of heat or energy meters as well as water meters to the controller. A maximum of six meters conforming to EN 1434-3 may be connected for data transfer.

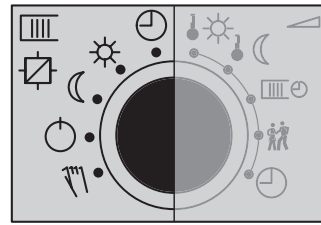
A heat meter (provided it supplies high-resolution measuring accuracy) can be used to limit flow rate and/or heat capacity. Different flow rate and capacity limits can be set for the operating states "Heating control only", "Heating control and domestic hot water heating" and "Domestic hot water heating only".





Operating modes

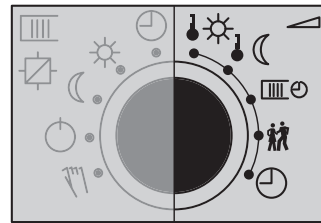

-  Time-controlled operation
-  Day mode
-  Night mode
-  Control operation deactivated, frost protection only
-  Manual operation:
Correction value adjusted in percent and pump activated/deactivated by pressing and turning the rotary pushbutton

Parameters



-  Day set point
-  Night set point
-  Times-of-use for heating
-  Party mode: setting of special times-of-use in steps of 15 minutes. Timer starts working immediately after it is set.
-  Controller clock:
setting of time, date and year

Domestic hot water circuit

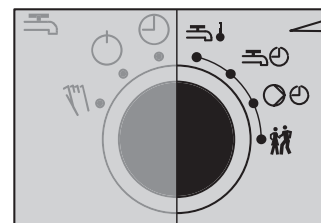





-  DHW temperature
-  Times-of-use for DHW
-  Times-of-use for DHW circulation pump
-  Party mode: setting of special times-of-use (one-off charging) in steps of 15 minutes. Timer starts working immediately after it is set.

Fig. 2: Switch positions and their meaning

Technical data

Inputs		15 configurable inputs for Pt 1000/Pt 100, PTC/Pt 100, NTC/Pt 100, Ni 1000/Pt 100 or Pt 500/Pt 100 temperature sensors and binary inputs, Input 17 alternatively for flow rate signal of heat meter or signal for external demand by subsequent controllers, 4(0) to 20 mA with 50 Ω parallel resistor or 0 to 10 V (demand: 0 to 10 V correspond to 20 to 120 °C flow temperature)
Outputs*		2 x three-step signal: load max. 250 V AC, 2 A Alternatively on/off signal: load max. 250 V AC, 2 A Alternatively continuous-action output: 0 to 10 V, load > 5 kΩ 4 x pump output: load max. 250 V AC, 2 A; all outputs are relay outputs with varistor suppression 2 x semiconductor relay: load max. 24 V AC/DC, 50 mA
Interfaces	Device bus	RS-485 interface for max. 32 bus devices (2-wire system, polarity independent, connection to terminals 29/30 as required or together with the two-wire system bus via 1400-8800 cable converter)
	System bus	RS-232 Modbus interface for modem or point-to-point connection to a PC (Modbus RTU protocol, data format 8N1, RJ 45 connector socket at the side) Optional: – RS-485 Modbus interface for four-wire bus using a cable converter (1400-7308) – RS-485 Modbus interface for two-wire bus using a cable converter (1400-8800)
	Meter bus	Optional: Meter bus plug-in module, protocol according to EN 1434-3 (also suitable for retrofitting)
Operating voltage		165 to 250 V, 48 to 62 Hz, max. 5 VA
Ambient temperature		0 to 40 °C (operation), –10 °C to 60 °C (storage and transport)
Degree of protection		IP 40 according to IEC 60529
Class of protection		II according to VDE 0106
Degree of contamination		2 according to VDE 0110
Overvoltage category		II according to VDE 0110
Humidity rating		F according to VDE 40040
Noise immunity		According to EN 61000-6-1
Noise emission		According to EN 61000-6-3
Weight		Approx. 0.5 kg

* For systems with two control circuits and five pumps, the second heating circuit can only use the 0 to 10 V output.

Electrical connection and installation

The controller consists of the housing containing the electronics and a separate terminal board for electrical connection. Two wires of max. 1.5 mm² may be connected to each terminal. The sensor connection lines must be installed separately from the lines carrying the power supply. For wall mounting, screw the terminal board to the wall. After wiring the controller, place the controller housing onto the terminal board and fasten it with two screws. Two fastening elements for panel mounting are included.

Dimensions in mm

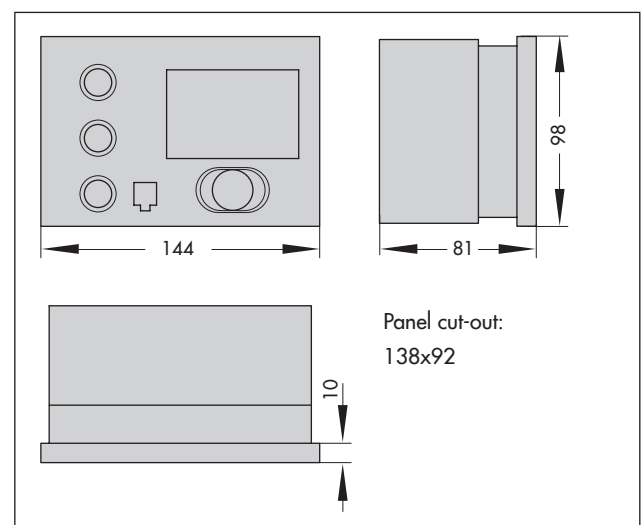

Terminal assignment

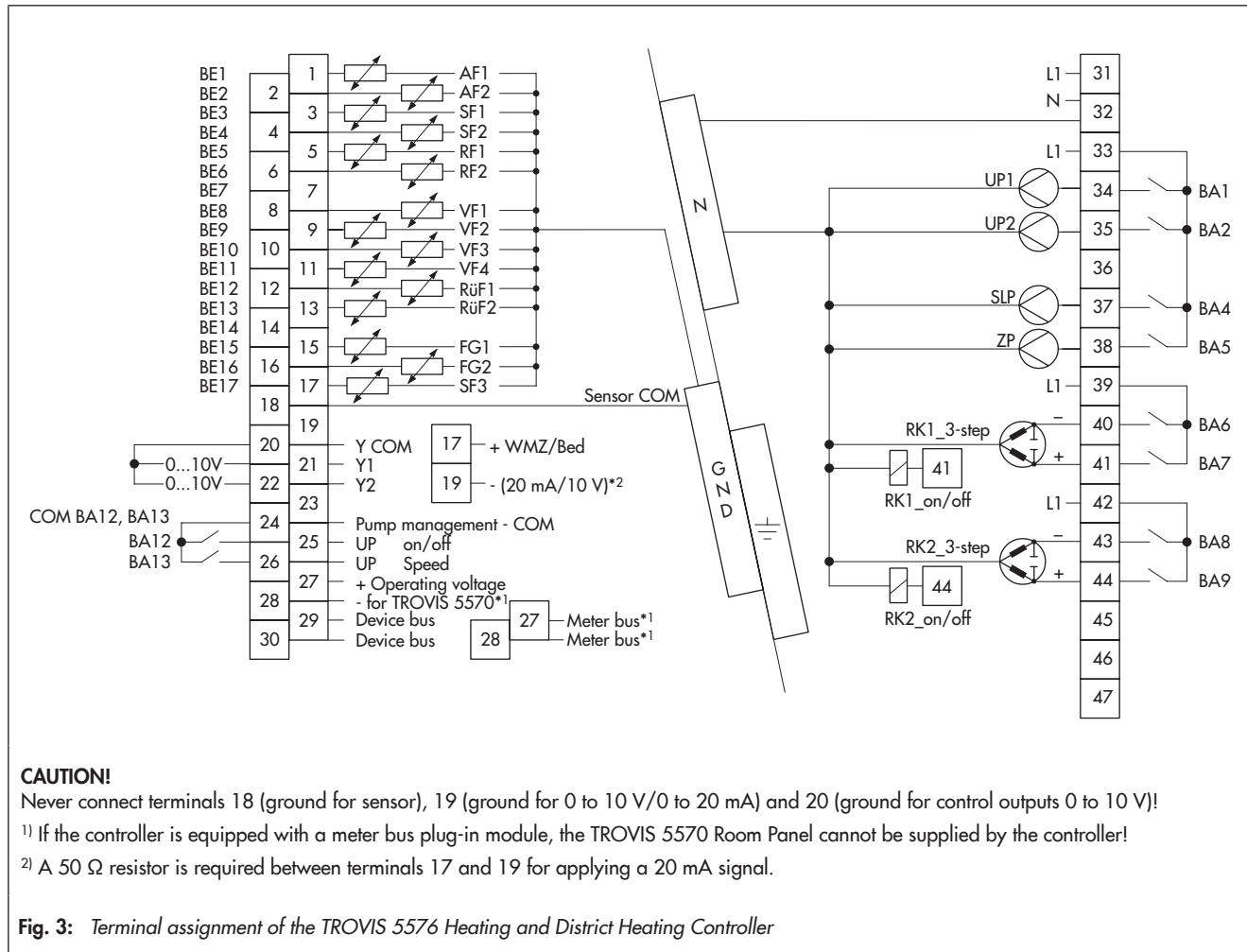

Ordering text

TROVIS 5576 Heating and District Heating Controller with RS-232 system bus interface for modem or point-to-point connection to a PC

Options:

Cable converter (1400-8800) for RS-485 two-wire system bus
 Cable converter (1400-7308) for RS-485 four-wire system bus
 Meter bus plug-in module (1400-8975)
 55Viewer visualization and operator interface (1400-9770)

Accessories:

- Room panels
 - Type 5244 · PTC sensor with room panel
 - Type 5257-5 · Pt 1000 sensor with room panel
 - TROVIS 5570 · room panel with display
- Memory module (1400-9379)
- Mini module (1400-7436)
- Data logging module (1400-9378)
- USB converter 3 together with data log viewer software (1400-9377)
- TROVIS-VIEW software (6661-1012) for TROVIS 5576

Specifications subject to change without notice.



SAMSON AG · MESS- UND REGELTECHNIK
 Weismüllerstraße 3 · 60314 Frankfurt am Main · Germany
 Phone: +49 69 4009-0 · Fax: +49 69 4009-1507
 Internet: <http://www.samson.de>

T 5576 EN

2012-06-06